



# SIM7000E NB-IOT HAT

## Overview

This Raspberry Pi HAT features multi communication functionalities: NB-IoT, eMTC, EDGE, GPRS, and GNSS.

The NB-IoT (NarrowBand-Internet of Things) and eMTC (enhanced Machine Type Communication) are rising IoT communication technologies evolved from LTE (4G), with advantages include low power, low cost, wide coverage, etc. They are suited for applications such as intelligent instruments, remote controlling, asset tracking, remote monitoring, E-health, mobile POS terminals, sharing bikes, and so on. While the GSM/GPRS, and EDGE are traditional 2G/2.5G technologies capable of sending SMS or making other wireless communications.

Therefore, the SIM7000E NB-IoT HAT would be an ideal choice for either evaluating new rising technologies, or simply communicating/positioning via multiple ways.

## Features

- Raspberry Pi connectivity, compatible with Raspberry Pi Zero/Zero W/Zero WH/2B/3B/3B+
- Supports TCP, UDP, PPP, HTTP, FTP, MQTT, SMS, Mail, etc.
- Supports GNSS positioning (GPS, GLONASS, BeiDou and Galileo)
- Onboard USB interface, to test AT Commands, get GPS positioning data, and so on
- Breakout UART control pins, to connect with host boards like Arduino/STM32
- Onboard voltage translator, 3.3V by default, allows to be switched to 5V via 0Ω resistor
- SIM card slot, compatible with both normal SIM card and NB-IoT specific card
- 2x LED indicators, easy to monitor the working status
- Baudrate: 300bps~3686400bps
- Control via AT commands (3GPP TS 27.007, 27.005, and SIMCOM enhanced AT Commands)
- Supports SIM application toolkit: SAT Class 3, GSM 11.14 Release 98, USAT
- Comes with development resources and manual (examples for Raspberry /Arduino/STM32)

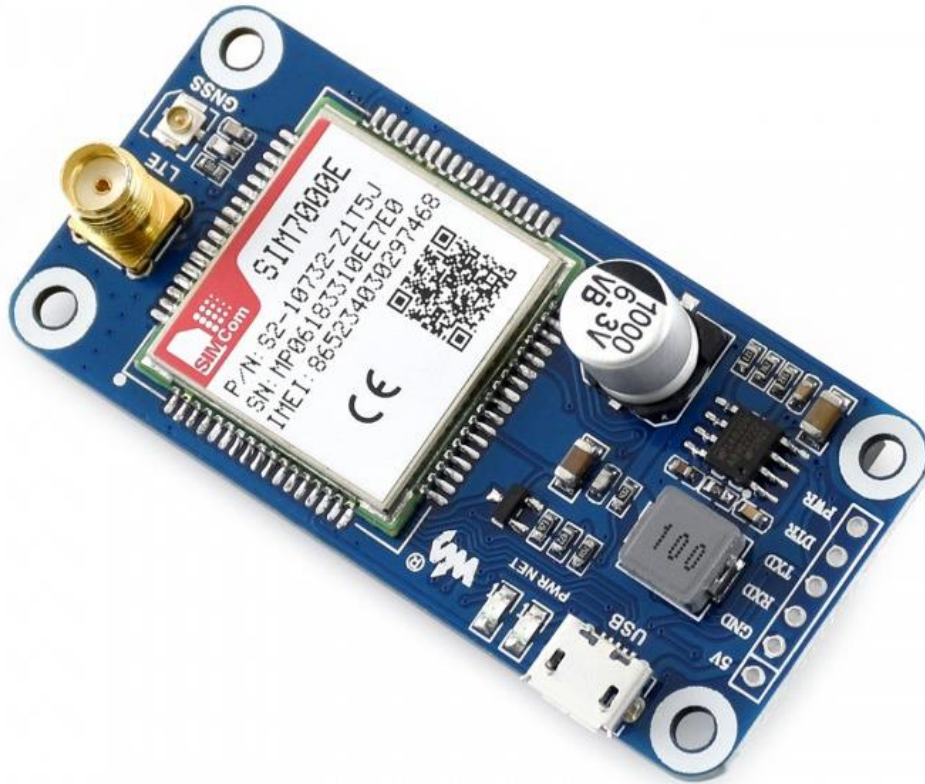

## Contents

Overview.....	1
Features.....	1
1. Hardware configuration.....	4
1.1. Hardware configuration .....	4
2. GPRS Debugging.....	6
2.1. General AT commands .....	6
2.2. Local virtual servers settings.....	7
2.3. Searching WAN IP .....	7
2.4. GPRS Setting .....	8
2.5. Sending data .....	8
2.6. Receiving data.....	9
2.7. Deactivating Connection .....	9
3. NB-IoT Debugging .....	9
3.1. General AT commands .....	9
3.2. Local virtual servers settings.....	错误!未定义书签。
3.3. Searching WAN IP .....	错误!未定义书签。
3.4. NB-IoT Setting.....	10
3.5. Sending data.....	11
3.6. Receiving data.....	11
3.7. Deactivating Connection .....	11
4. GNSS Debugging.....	12

4.1.	General AT commands .....	12
4.2.	GPS Debugging.....	12
5.	Using with Raspberry Pi .....	14
5.1.	Interface overview.....	14
5.2.	UART configuration of Raspberry Pi .....	14
5.3.	Minicom for UART debugging on Raspberry Pi .....	15
5.4.	Examples.....	16
5.4.1.	AT_Test .....	16
5.4.2.	GPS_Positioning .....	17
5.4.3.	NB-IoT (TCP_IP) .....	18
5.4.4.	For more demo code,please visit the website wiki.....	18

## 1. Hardware configuration

### 1.1. Hardware configuration

This module comes with GSM antenna, GPS antenna and micro USB cable. Besides these you should prepare a sim card or a nb-iot card:

- 1) Insert the SIM card to the card slot and connect the GSM antenna.
- 2) Connect the USB interface of SIM7000E NB-IoT HAT to PC with a micro USB cable. Then the PWR indicator will keep bright.

**Figure : Hardware connection**

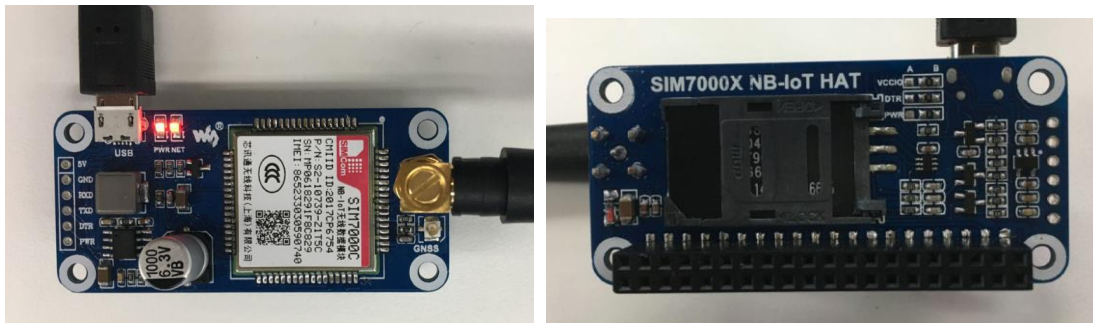

- Generally, the NET indicator will fast flash firstly (1 time per second), which means that the module has not logged in the Network. After logging in, the indicator become to flash slowly (1 time every three seconds). Up to the local GSM network, this process that logging in will last several seconds to dozens of seconds.

If you take too much time to log in and failed, please check that whether the GSM antenna is connected correctly, and whether the SIM card is usable and insert correctly.

- Install SIM7000 driver (windows driver: [www.waveshare.com/wiki/File:SIM7X00-Driver.7z](http://www.waveshare.com/wiki/File:SIM7X00-Driver.7z))  
Open Device Manager to get the corresponding COM port number of SIM7000. For example, the AT Port is COM19 as below. Users need to choose the correct port according to the Manager.

Figure: Devices Manager

- SimTech HS-USB AT Port 9001 (COM25)
- SimTech HS-USB Audio 9001 (COM24)
- SimTech HS-USB Diagnostics 9001 (COM28)
- SimTech HS-USB NMEA 9001 (COM27)

## 1.2. Solder joints

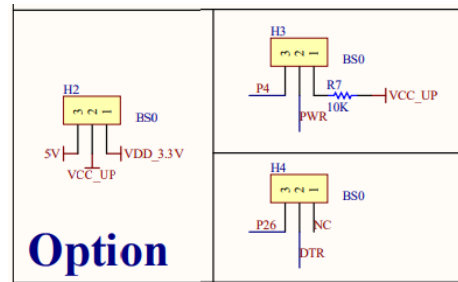

Pin \ Solder	Soldered to A side	Soldered to B side
<b>VCCIO</b>	5V	3.3V (Default)
<b>DTR</b>	P26	NC (Default)
<b>PWR</b>	P4 (Control power supply via pin)	3.3V (Default:Power on automatically)

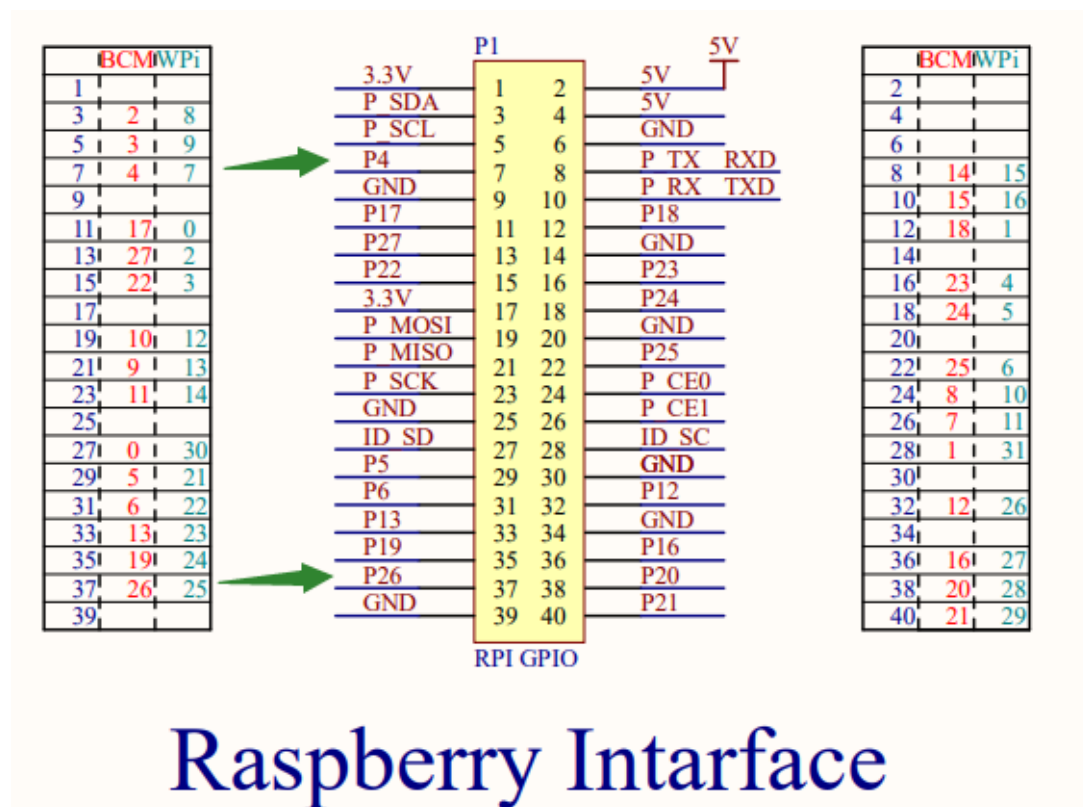

## 2. GPRS Debugging

### 2.1. General AT commands

Commands	Description	Return
AT+CGATT?	Check the state of GPRS attachment	+CGATT:1

		1 Attached
AT+CSTT?	AT+CSTT? : Check available APN	+CSTT:
AT+CSTT	AT+CSTT = "cmnet": Set APN to CMNET	OK
AT+CIICR	Bring up wireless connection with GPRS	OK
AT+CIFSR	Get local IP address	OK
AT+CIPSTART	AT+CIPSTART="Mode", "IP_Addr", "Port" Mode: connection type; IP_Addr: Remote server IP address; Port: Remote server port	CONNECT OK
AT+CIPSEND	Send data	OK
1A	(HEX format) Tell module to send data	SEND OK
AT+CIPCLOSE	Close TCP or UDP connection	CLOSE OK
AT+CIPSHUT	Deactivate GPRS PDP Context	SHUT OK

## 2.2. Local virtual servers settings

Virtual servers define the mapping between service ports of WAN and web servers of LAN. All requests from Internet to service ports of WAN will be redirected to the computer (web servers of LAN) specified by the server IP. (see your router's guide manual)

- 1) Log in Management Console of your router with browser (read your router's guide manual for specific address)
- 2) Set Port: 1822 (The Port can't be conflict to other's. Here we set 1822)
- 3) Set LAN IP address of your computer (you can run CMD on your computer, and execute command ipconfig to enquiry the address of IPv4), 192.168.6.168 as examples

SIM7000 Test	wan1_pp poe1	TCP/UDP	1822-1822	1822-1822	192.168.6.168
--------------	-----------------	---------	-----------	-----------	---------------

## 2.3. Searching WAN IP

You can search "IP" on browser to get your WAN IP address.

## 2.4. GPRS Setting

- 1) AT+CSQ //To enquiry the quality of signal. The first parameter of response is signal quality (Max is 31). The signal stronger, the value bigger.
- 2) AT+CREG? //Check Network registration. If the second parameter of response is 1 or 5, it means that Network has been registered successfully
- 3) AT+CGATT? // Check the state of GPRS attachment
- 4) AT+CSTT="CMNET" //Set the Network according to actual situation. Here we use CMNET
- 5) AT+CIICR //Bring up wireless connection with GPRS
- 6) AT+CIFSR //Get the local IP address
- 7) AT+CIPSTART="TCP","113.81.232.178",1822 //Established TCP/IP connection

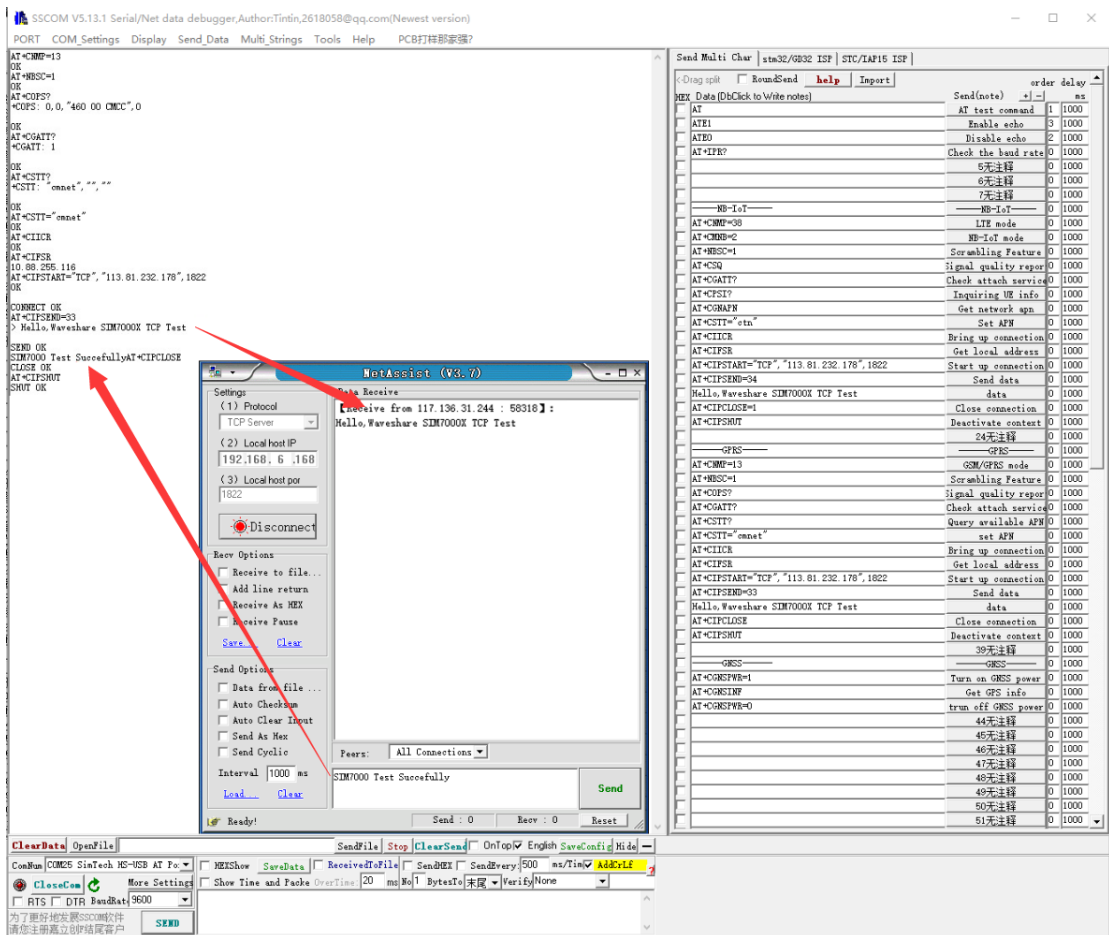

## 2.5. Sending data

- 1) AT+CIPSEND=33 //Send fixed length data
- 2) AT+CIPSEND // Send changeable length data



- 3) After getting the response >, edit the contents of message (has been converted) without Enter at the end. Then send 1A in HEX format as below
- 4) If the data sent successfully, the server will receive the data.

## 2.6. Receiving data

- 1) Choose the IP address of module on peers input box
- 2) Input the data which you want to send: SIM7000 Test Succesfully
- 3) Click Send button, you can see that module receive the data with COM assistant software

## 2.7. Deactivating Connection

- 1) Send AT+CIPCLOSE or AT+CIPSHUT to deactivate connection.

# 3. NB-IoT Debugging

## 3.1. General AT commands

Commands	Description	Return
AT+CGATT?	Check the state of GPRS attachment	+CGATT:1 1 Attached
AT+CPSI?	AT+CPSI?: Inquiring UE information	+CPSI: OK
AT+CGNAPN	Check available APN	+CGNAPN: OK
AT+CSTT	AT+CSTT = "cmnet": Set APN to CMNET	OK
AT+CIICR	Bring up wireless connection with GPRS	OK
AT+CIFSR	Get local IP address	OK
AT+CIPSTART	AT+CIPSTART="Mode", "IP_Addr", "Port" Mode: connection type; IP_Add: Remote server IP address; Port: Remote server port	CONNECT OK
AT+CIPSEND	Send data	OK

1A	(HEX format) Tell module to send data	SEND OK
AT+CIPCLOSE	Close TCP or UDP connection	CLOSE OK
AT+CIPSHUT	Deactivate GPRS PDP Context	SHUT OK

### 3.2. NB-IoT Setting

- 1) AT+CSQ //To enquiry the quality of signal. The first parameter of response is signal quality (Max is 31). The signal stronger, the value bigger.
- 2) AT+CREG? //Check Network registration. If the second parameter of response is 1 or 5, it means that Network has been registered successfully
- 3) AT+CGATT? // Check the state of GPRS attachment
- 4) AT+CPSI? // Inquiring UE system information
- 5) AT+CGNAPN // Get network APN in CAT-M or NB-IOT
- 6) AT+CSTT="T" //Set the Network according to actual situation. Here we use T
- 7) AT+CIICR //Bring up wireless connection with GPRS
- 8) AT+CIFSR //Get the local IP address
- 9) AT+CIPSTART="TCP","118.190.93.84",2317 //Established TCP/IP connection

```

AT+CNMP?
+CNMP: 13

OK
AT+CNMP=13
OK
AT+NBSC=1
OK
AT+CUFS?
+COFS: 0,0,"460 00 CMCC",0

OK
AT+CGATT?
+CGATT: 1

OK
AT+CSST?
+CSST: "CMNET","",""

OK
AT+CSST="cmnet"
OK
AT+CIICR
OK
AT+CIPSR
10.147.17.105
AT+CIPSTART="UDP","118.190.93.84",2317
OK

CONNECT OK
AT+CIPSEND=33
> Hello,Waveshare SIM7000X TCP Test

SEND OK
Hello,Waveshare SIM7000X TCP TestAT+CIPCLOSE
CLOSE OK
AT+CIPSHUT
SHUT OK

```

### 3.3. Sending data

- 5) AT+CIPSEND=33 //Send fixed length data
- 6) AT+CIPSEND // Send changeable length data
- 7) After getting the response >, edit the contents of message (has been converted) without Enter at the end. Then send 1A in HEX format as below
- 8) If the data sent successfully, the server will receive the data.

### 3.4. Receiving data

- 4) Choose the IP address of module on peers input box
- 5) Input the data which you want to send: SIM7000 Test Successfully
- 6) Click Send button, you can see that module receive the data with COM assistant software

### 3.5. Deactivating Connection





Send AT+CIPCLOSE or AT+CIPSHUT to deactivate connection.

## 4. GNSS Debugging

### 4.1. General AT commands

Commands	Description	Return
AT+CGNSPWR	GNSS Power Control: AT+CGNSPWR =1:Turn on AT+CGNSPWR =0:Turn off	OK
AT+CGNSTST	AT+CGNSTST=1:Send data received to AT Port AT+CGNSTST=0: Stop sending data received to AT Port	OK
AT+CGNSINF	GNSS navigation information parsed from NMEA sentences	+CGNSINF: OK

### 4.2. GPS Debugging

- 1) Connecting the GPS antenna, and place the receiver on open area outdoor
- 2) AT+CGNSPWR=1 //Turn on power of GPS
- 3) AT+CGNSTST=1 // Start to sending data received to AT Port  
 Open u-center and set the Port and Baudrate(AT Port, COM25).  
 Of course, you can use another port(NMEA Port,COM27)
  -  SimTech HS-USB AT Port 9001 (COM25)
  -  SimTech HS-USB Audio 9001 (COM24)
  -  SimTech HS-USB Diagnostics 9001 (COM28)
  -  SimTech HS-USB NMEA 9001 (COM27)
- 4) AT+CGNSTST=0 // Stop sending data received to UART
- 5) AT+CGNSINF // Print the GPS information
- 6) AT+CGNSPWR=0 //Turn off power of GPS



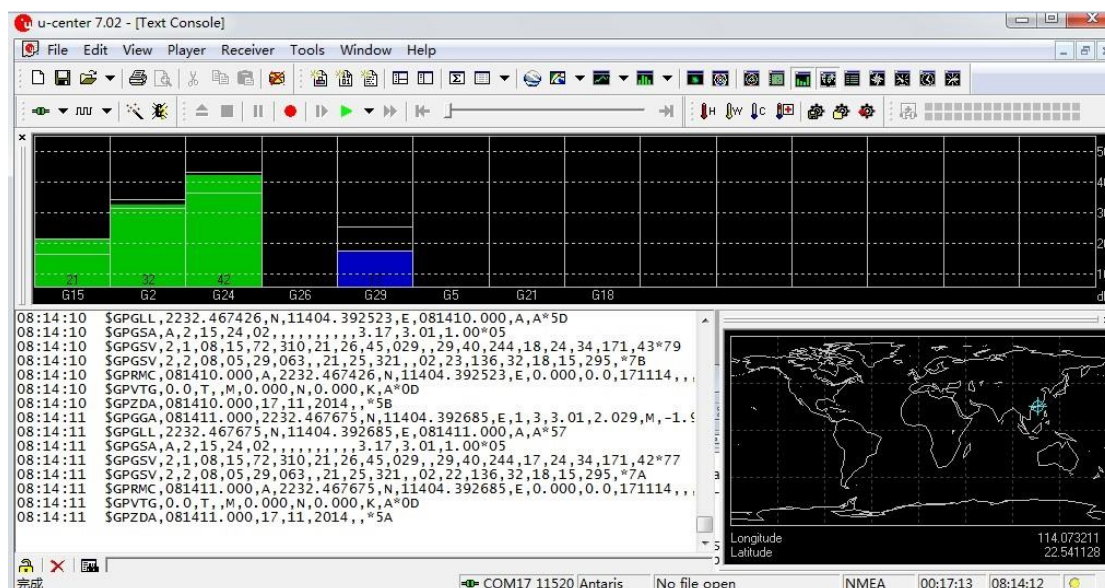

## 5. Using with Raspberry Pi

### 5.1. Interface overview

The default relationship between SIM7000 control pins and Raspberry Pi IOs is shown in Table 1.

**Table 1: The relationship between SIM7000 control pins and Raspberry Pi IOs**

SIM7000	IO of Raspberry Pi B+	Description
5V	5V	Power supply (5V)
GND	GND	Ground
TXD	P15 / RXD	UART pin
RXD	P14 / TXD	UART pin
PWR	P4 (Need to modify the back solder joint)	Power up the module

### 5.2. UART configuration of Raspberry Pi

Because UART of Raspberry Pi is used for Linux console output by default, if we want to use the UART, we need to change the settings. Executing this command to enter the configuration page :

```
sudo raspi-config
```

Choose `Interfacing Options -> Serial -> no->yes`, to disable Linux's use of console UART. Open `/boot/config.txt` file, find the below statement and uncomment it to enable the UART. You can directly append it at the end of file as well.

```
enable_uart=1
```

Then reboot.

### 5.3. Minicom for UART debugging on Raspberry Pi

Inserting the module to Raspberry Pi and plug the jumper B,

Install minicom, minicom is a text-based modem control and terminal emulation program for Linux:

```
sudo apt-get install minicom
```

Execute command: `minicom -D /dev/ttyS0` (`ttyS0` is the UART of Raspberry Pi 3B)

Baud rate is 115200 by default. If you need to change the baud rate, for example 9600, you can add the parameter `-b 9600`.

The user UART device of Raspberry Pi 2B/Zero is `ttyAMA0`, and `ttyS0` of Raspberry Pi 3B

Testing Bluetooth function as examples:

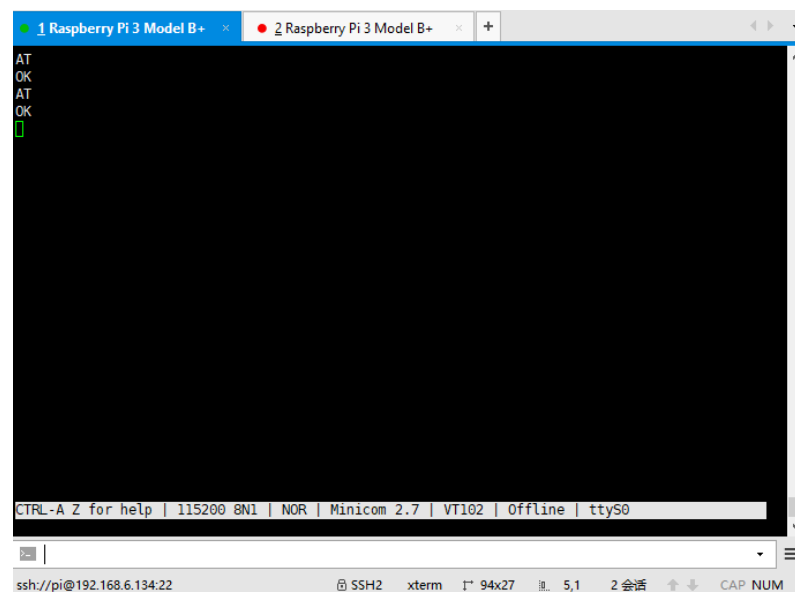

```
AT
OK
AT
OK
█

CTRL-A Z for help | 115200 8N1 | NOR | Minicom 2.7 | VT102 | Offline | ttyS0
ssh://pi@192.168.6.134:22  SSH2  xterm  94x27  5,1  2会话  CAP NUM
```

## 5.4. Examples

Download the demo code from wiki and copy to the Raspberry Pi (for example, /home/pi/SIM7000X)

Enter the bcm2835 directory, compile and install the BCM2835 library:

```
chmod +x configure && ./configure && sudo make && sudo make install
```

```
pi@raspberrypi:~/SIM7000X/bcm2835 $ ./configure & make & sudo make check & sudo make install
[1] 26103
[2] 26104
[3] 26105
make all-recursive
make[1]: Entering directory '/home/pi/SIM7000X/bcm2835'
Making install in src
Making check in src
Making all in src
make[1]: Entering directory '/home/pi/SIM7000X/bcm2835/src'
make[1]: Entering directory '/home/pi/SIM7000X/bcm2835/src'
make test
make[2]: Entering directory '/home/pi/SIM7000X/bcm2835/src'
make[2]: Nothing to be done for 'all'.
make[2]: Leaving directory '/home/pi/SIM7000X/bcm2835/src'
Making all in doc
make[2]: Entering directory '/home/pi/SIM7000X/bcm2835/doc'
make[2]: Nothing to be done for 'all'.
make[2]: Leaving directory '/home/pi/SIM7000X/bcm2835/doc'
make[2]: Entering directory '/home/pi/SIM7000X/bcm2835/src'
make[2]: Entering directory '/home/pi/SIM7000X/bcm2835/src'
make[2]: Entering directory '/home/pi/SIM7000X/bcm2835'
/bin/mkdir -p '/usr/local/lib'
gcc -g -O2 -o test test.o ./libbcm2835.a -lrt
/usr/bin/install -c -m 644 libbcm2835.a '/usr/local/lib'
```

### 5.4.1. AT\_Test

```
cd example/AT_Test && sudo ./AT_Test
```



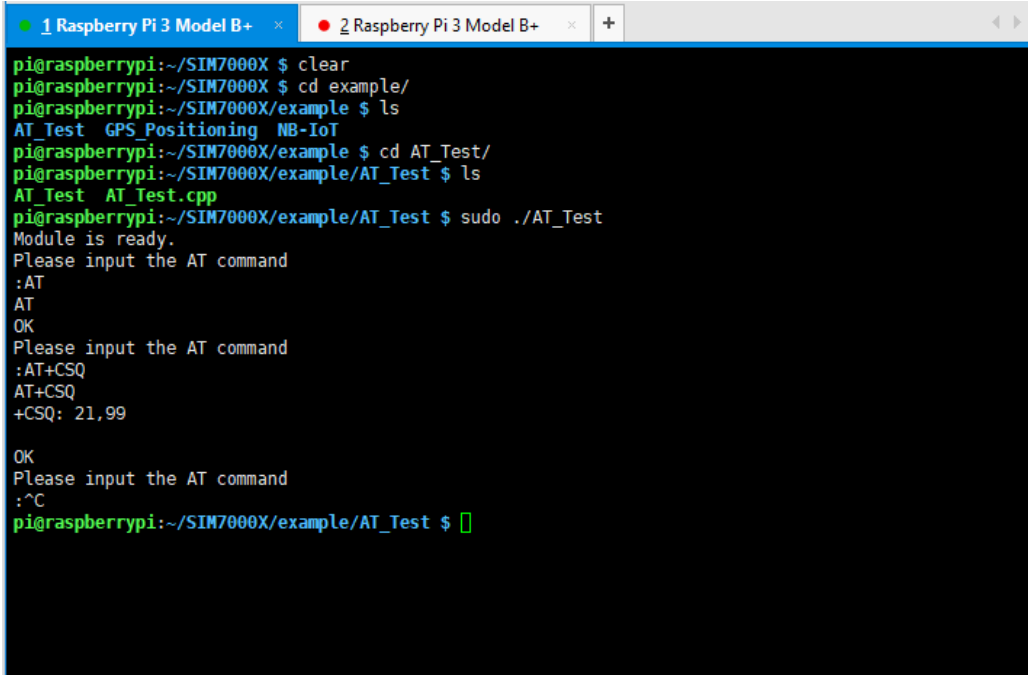

```
pi@raspberrypi:~/SIM7000X $ clear
pi@raspberrypi:~/SIM7000X $ cd example/
pi@raspberrypi:~/SIM7000X/example $ ls
AT_Test  GPS_Positioning  NB-IoT
pi@raspberrypi:~/SIM7000X/example $ cd AT_Test/
pi@raspberrypi:~/SIM7000X/example/AT_Test $ ls
AT_Test  AT_Test.cpp
pi@raspberrypi:~/SIM7000X/example/AT_Test $ sudo ./AT_Test
Module is ready.
Please input the AT command
:AT
AT
OK
Please input the AT command
:AT+CSQ
AT+CSQ
+CSQ: 21,99

OK
Please input the AT command
:^C
pi@raspberrypi:~/SIM7000X/example/AT_Test $
```

#### 5.4.2. GPS\_Positioning

```
cd example/GPS_Positioning && sudo ./GPS_Positioning
```

```

pi@raspberrypi:~/SIM7000X $ cd example/GPS_Positioning/
pi@raspberrypi:~/SIM7000X/example/GPS_Positioning $ ls
GPS_Positioning  GPS_Positioning.cpp
pi@raspberrypi:~/SIM7000X/example/GPS_Positioning $ ./GPS_Positioning
Failed to open /dev/mem, try checking permissions.
Failed to map the physical GPIO registers into the virtual memory space.
bcm2835_init: Unable to open /dev/mem: Permission denied
pi@raspberrypi:~/SIM7000X/example/GPS_Positioning $ sudo ./GPS_Positioning
Module is ready.
Ready for GPS positioning,
please connect the GPS antenna and place it outdoors
1,0,,,,,,0,,,,,12,,,,42,,

OK
The GPS position message is not correct,please waiting...
1,0,,,,,,0,,,,,12,,,,43,,

OK
The GPS position message is not correct,please waiting...
The GPS position message is:
1,1,20180601073419.000,22.544040,114.077940,80.700,0.00,176.5,1,,0.7,,,,12,9,,,44,,

OK
UTC time is :20180601073419
Latitude is :22.544040
Longitude is :114.077940
Turn off the GNSS power.
█
  
```

### 5.4.3. NB-IoT (TCP\_IP)

```
cd example/NB-IoT && sudo ./TCP_IP
```

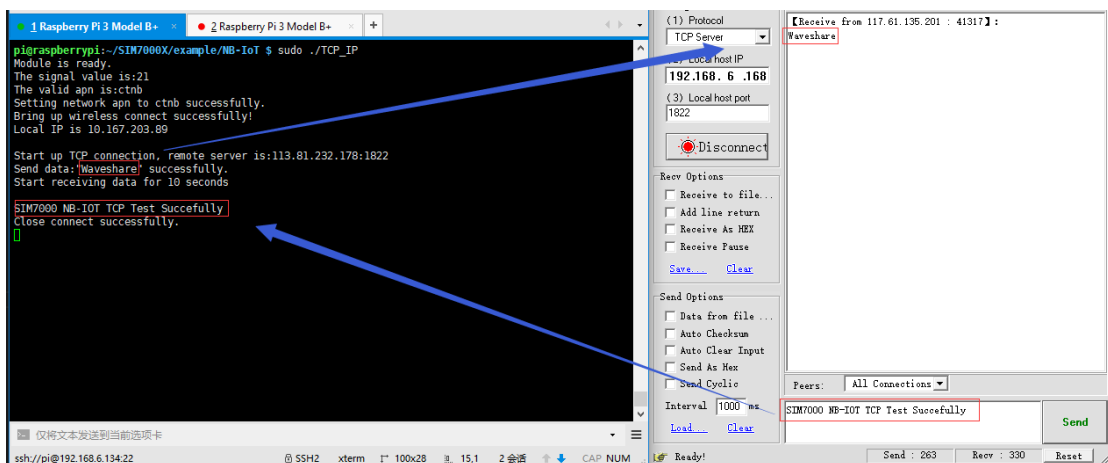

```

pi@raspberrypi:~/SIM7000X/example/NB-IoT $ sudo ./TCP_IP
Module is ready.
The signal value is:21
The valid apn is:ctnb
Setting network apn to ctnb successfully.
Bring up wireless connect successfully!
Local IP is 10.167.203.89

Start up TCP connection, remote server is:113.81.232.178:1822
Send data:'Waveshare' successfully.
Start receiving data for 10 seconds

SIM7000 NB-IOT TCP Test Successfully
Close connect successfully.
█
  
```

5.4.4. For more demo code, please visit the website wiki.